

Conforms to ASME PASE-2014

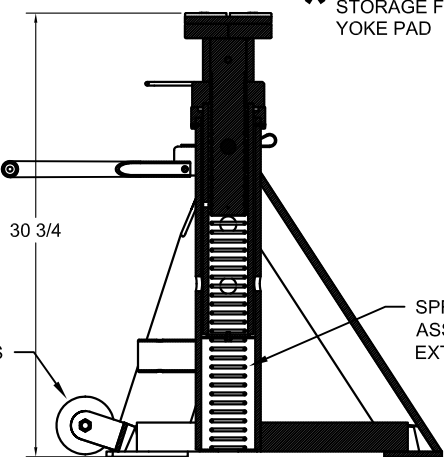
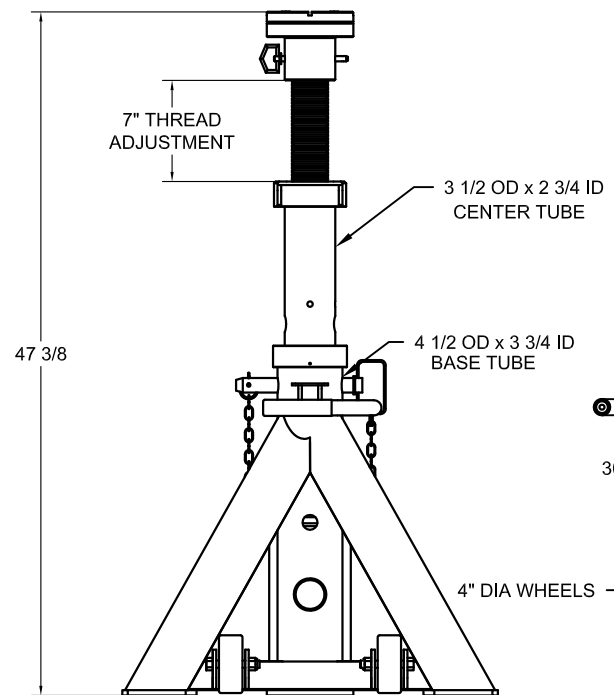
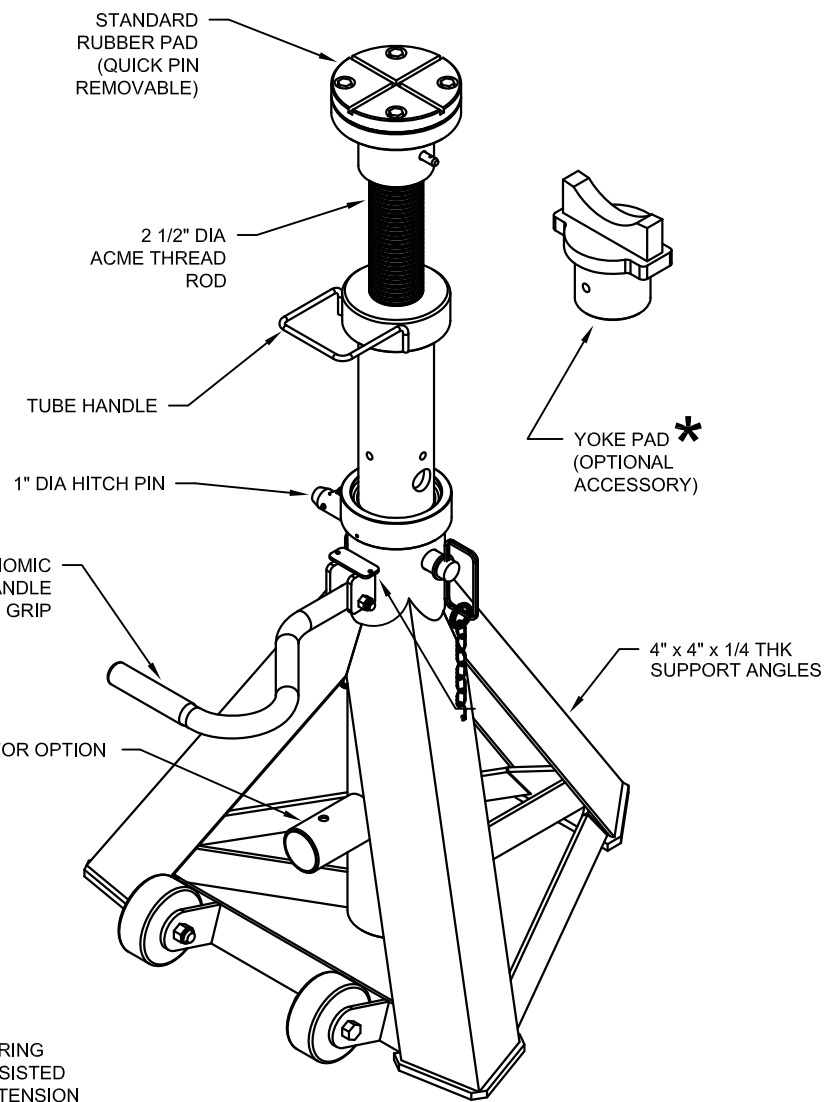

MOHAWK JACK STAND  
MODEL #JS-3047-30  
CAPACITY: 30,000 LB

C-SIZE

**NOTICE OF CONFIDENTIAL INFORMATION**

INFORMATION CONTAINED HEREIN IS CONFIDENTIAL AND PROPERTY OF MOHAWK RESOURCES LTD., WHERE DRAWING IS FURNISHED TO OTHERS IT SHALL BE USED SOLELY FOR PURPOSES OF INSPECTION, INSTALLATION, OR MAINTENANCE. THE INFORMATION SHALL NOT BE USED OR DISCLOSED BY THE RECIPIENT FOR ANY OTHER PURPOSES WHATSOEVER.

**NOTES:**

1. REMOVE ALL SHARP CORNERS & EDGES.
2. UNLESS OTHERWISE SPECIFIED, SURFACE FINISH TO BE 125 RMS.
3. WELDING MEDIUM SHALL CONFORM TO AWS SPECIFICATIONS TO E-70XX ELECTRODES OR E-70TI CODE 5.3 FLUX CORE WIRE ONLY.

**TOLERANCES:**  
ANGULAR ± 1°  
FRACTIONAL ± .030  
DECIMAL:  
0.XX ± .030  
0.XXX ± .005

FILE NAME  
JS-000-A-SPEC13

JS-000-A-015

NEXT ASSEMBLY

SCALE  
1/10

CHECKED

DATE  
9/2016

DRAWN  
rww7089

APPROVED

WEIGHT  
183 LB.

**MOHAWK RESOURCES LTD.**

TITLE Jack Stand (PASE VERSION)  
JS-3047-30

FRDM  
N/A

DRAWING NUMBER  
JS-000-A-SPEC13

